

 certainteed
SAINT-GOBAIN

Restoration Millwork[®]

Exterior Trim

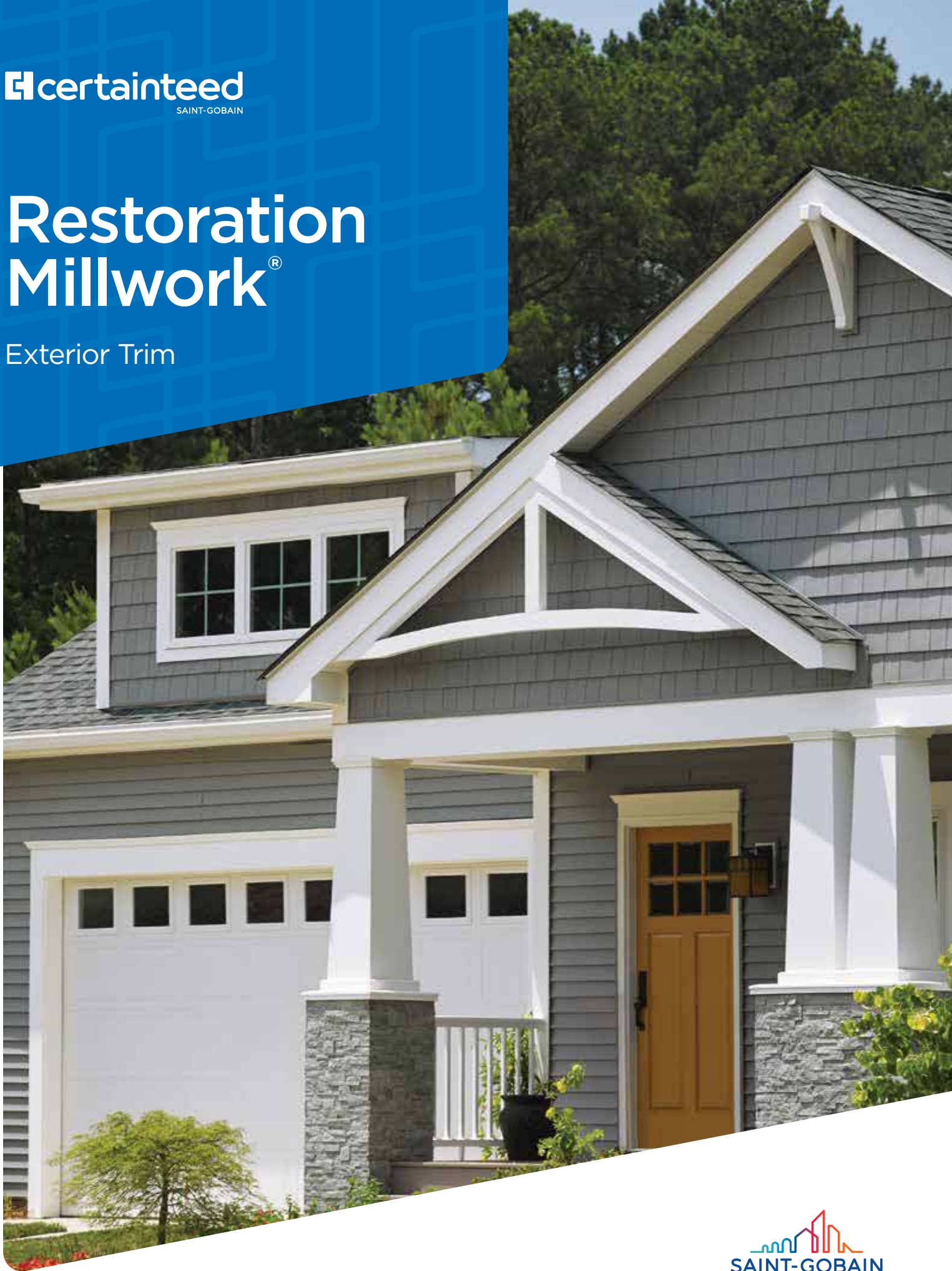

SAINT-GOBAIN

Create an exterior with real curb appeal...

On Cover

Siding: Cedar Impressions Double 7" Straight Edge Perfection Shingles and Monogram Double 4" Clapboard in Charcoal Gray.

Trim: Restoration Millwork® sheets and trimboards.



Multiple profiles used in water-table application and skirting.



Sheets, Beadboard and Shingle Mould with Trimboard.



J-Pocket Corner and Trimboard combination.



From distinctive charm to timeless style, homes dressed in Restoration Millwork trim have curb appeal that always generates a second admiring look. With so many options in trim styles, there's no limit to what you can create.

High-Performance Cellular PVC

While CertainTeed cellular PVC looks and feels like top-grade lumber, it provides performance and aesthetic advantages that wood and other materials just can't match.

- Superior quality and excellent dimensional accuracy
- Low maintenance and long-lasting UV-resistant material
- Natural white and ready to install
- Can be painted* to complement exterior colors
- Cuts and mills with traditional woodworking tools
- Class A (Class 1) Flame Spread Classification
- Meets ICC and CCMC code requirements
- Made in U.S.A.
- Contains recycled content
- 25-year limited warranty



*See Installation Guide (RM003) for instructions on painting.



Sheets routed into sunburst window header with heat formed Back Band.



Multiple profiles used in heat formed application.



Crown and Base Cap build-up with Beadboard Panel ceiling.

Make a Beautiful Entrance



First Impressions



Open the door, or window, to creative expression with Restoration Millwork profiles. From traditional and subdued to playful or dramatic, Restoration Millwork's broad range of profiles can be combined into design elements that can highlight and add drama to entranceways, while framing windows with added flair.

Choose from a variety of profiles to create any variation for door and window surrounds. For more information and great ideas, see the Restoration Millwork Profile Applications brochure (RMO45) at certainteed.com.

BACK BAND



RAMS CROWN TRIM BOARD



SHINGLE MOULD TRIM BOARD



BRICK MOULD



BASE CAP

Base mouldings provide a grounding element of architectural millwork appropriate for any traditional or contemporary application requiring exceptional depth of wood work design.

CROWN MOULDING

Derived from a classic style dating back to the golden age of Greek architecture, #45, #47 and #49 crown is used to bridge the corner between wall and ceiling.

BED MOULD

Historically the moulding or group of mouldings immediately beneath the corona of a cornice that is used as a transition above the frieze.

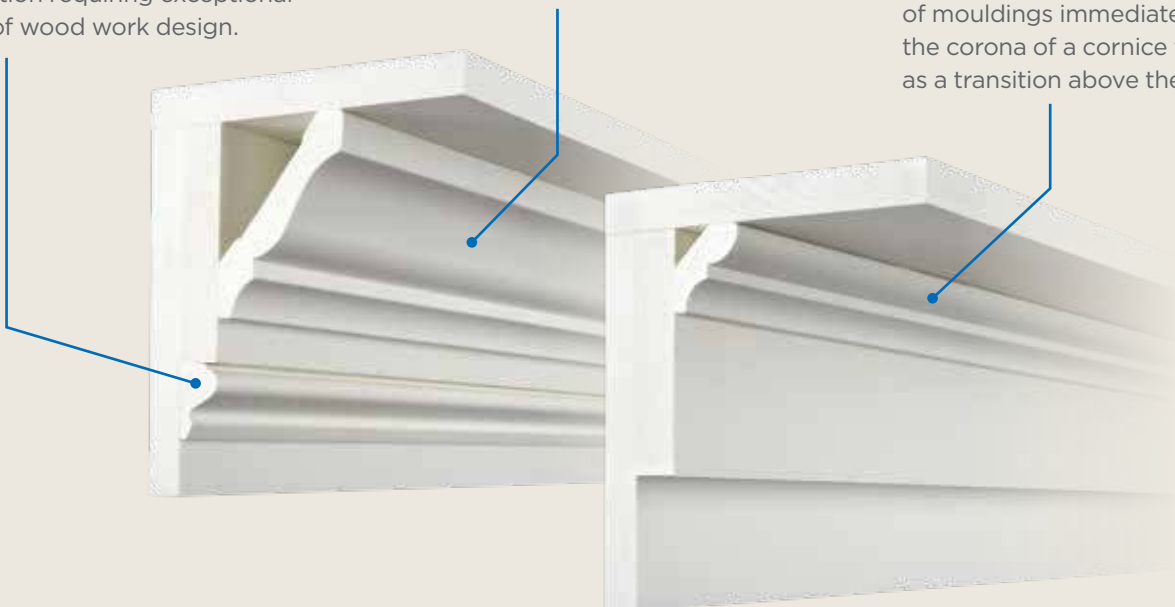

Decorative Mouldings

45/47/49 Crown

- Exterior Ceiling/Soffit (as shown)
- Exterior with 1x Frieze
- Head of Window/Door

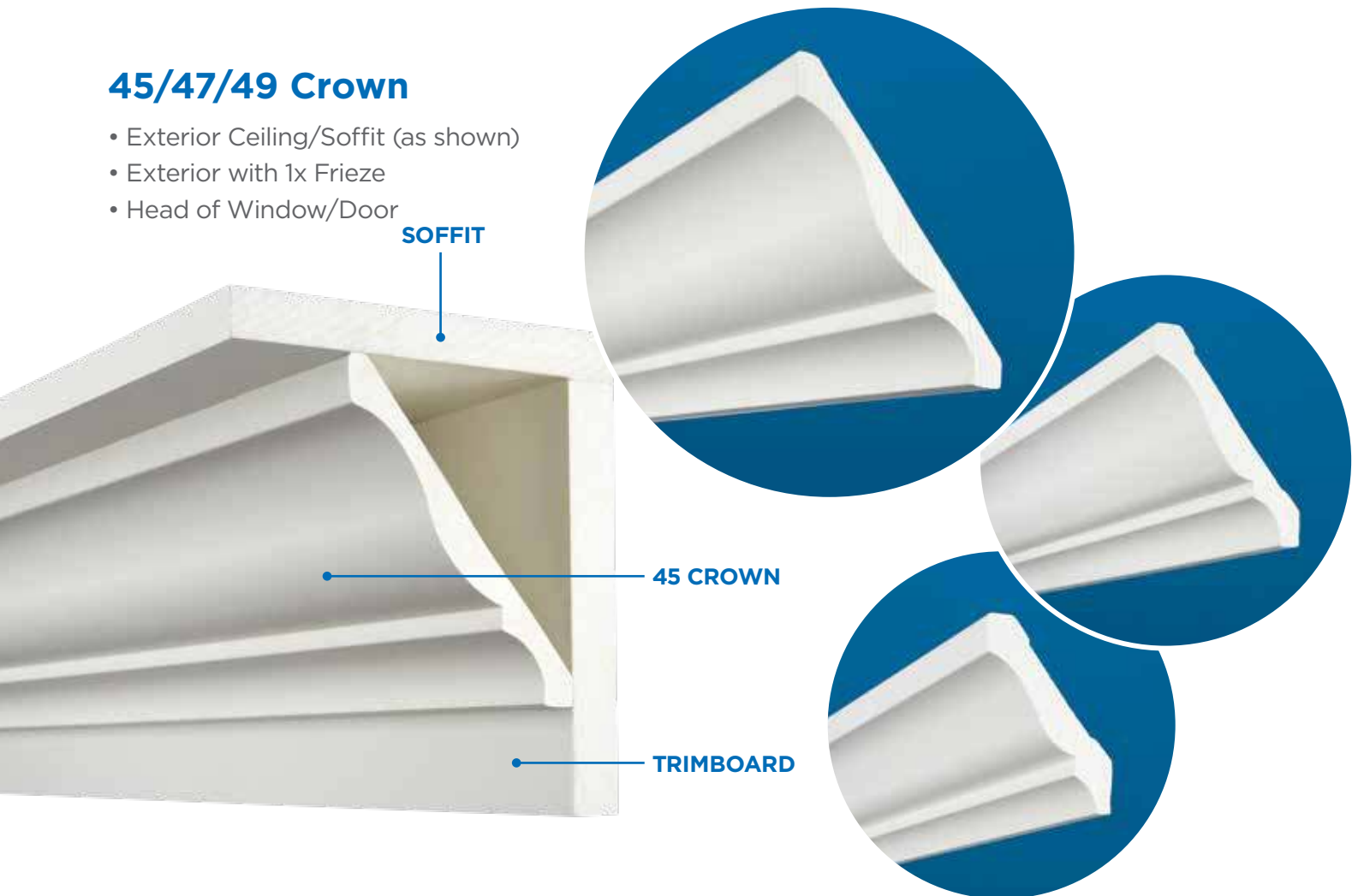

45 Crown		47 Crown		49 Crown	
Size	Length	Size	Length	Size	Length
9/16 in. x 5-1/4 in.	16 ft.	11/16 in. x 4-5/8 in.	16 ft.	11/16 in. x 3-5/8 in.	16 ft.

Rams Crown

- Window Header—Crown Mould Look (as shown)
- Gable over 1x
- Column/Frieze Board Detail

Rams Crown	
Size	Length
1-13/32 in. x 2-1/16 in.	16 ft.



Brickmould

- Door Casing (as shown)
- Window Casing (Brick)
- Garage Door Trim

Brickmould	
Size	Length
1-1/8 in. x 2 in.	7 ft.
1-1/8 in. x 2 in.	10 ft.
1-1/8 in. x 2 in.	17 ft.



J-Channel Brickmould

- Door Casing
- Window Casing
- Gable/Frieze Application

J-Channel Brickmould	
Size	Length
1-1/4 in. x 2 in.	17 ft.

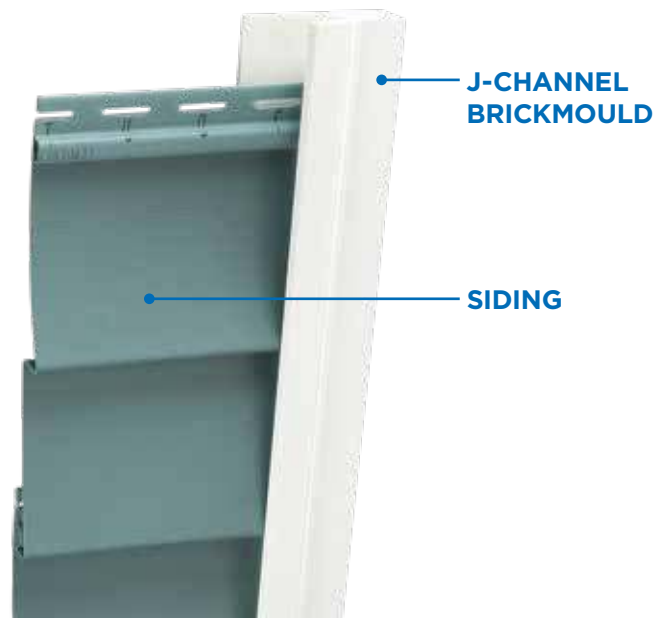
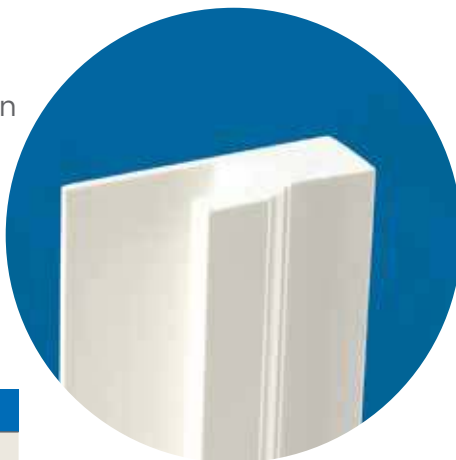

RB3 Casing

- Window & Door Surround (as shown)
- Double Stack Trim
- Over Garage Door

356 Casing	
Size	Length
1-7/64 in. x 3-7/16 in.	16 ft.



Coordinate, contrast or complement with CertainTeed exterior siding colors.

Restoration Millwork stays beautiful without the need for painting. However, you can paint Restoration Millwork using CertainTeed certified paints & stains. Sherwin-Williams® VinylSafe™ paints* are comprised of tints formulated to follow CertainTeed's best-in-the industry exterior products color palette. AquaSurTech™ extremely fast air dry and quick clean up paints are CertainTeed approved, as well as their TruStain™ product which provides a real wood stain look to the PVC product.



Start exploring preset color combinations and create your own custom exterior with on-line, interactive tools, designed to help you "Visualize Your Home" **Start now at certainteed.com/colortools**



**Sherwin-Williams VinylSafe Technology colors must be used when choosing darker colors that have a Light Reflecting Value (LRV) of 54 or lower. For colors with a LRV of 55 or higher (the higher the LRV, the lighter the color), you can safely use an acrylic latex paint.*



Custom-painted Restoration Millwork

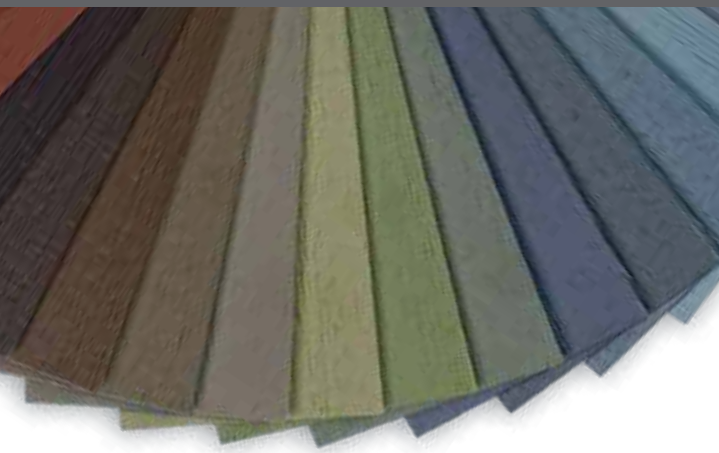

Make a statement with color

Trim color can have a dramatic effect on the look of your home.



Similar colors give you a blended look. An accent color can work in complementary fashion.



Choose a bolder accent to create striking contrasts.



Painted Restoration Millwork in Forest

Installs Clean with Protective Film

Individual trimboards are equipped with a protective film, protecting trimboards from smudges, dust and dirt. Boards are protected right up to installation, eliminating the need for job-site cleanup.



Hidden Fastening System

Fast and simple, the Hidden Fastening System makes fastener heads virtually invisible—resulting in a far more beautiful finished look. Fasteners provide a strong connection that can be painted. Use with CertainTeed Restoration Millwork PVC trim in both smooth and TrueTexture™ finishes. Available in 50, 250 and 750 lineal foot packages.

See **Installation Guidelines** (RM003) for more information on painting and fastening.



Sustainability for a lifetime

CertainTeed respects the environment through the responsible development of sustainable building products and systems. CertainTeed cellular PVC Trim gives building professionals and homeowners confidence that the homes they design, build, maintain, and occupy are made with sustainable materials that enhance every project's performance and beauty.

The Elements of Style

In the hands of a true craftsman, millwork is a tool for expressing creativity, attention to detail and a commitment to quality. With Restoration Millwork, there are so many ways for a craftsman to make his mark — and for homeowners to define their style. From accents to details, traditional designs to contemporary statements, Restoration Millwork’s broad selection of millwork components and trimboard sizes make it easy to create a distinctive custom look.



Shingle Mould
11/16 in. x 1-5/8 in. x 16 ft.



RB3 Casing
1-7/64 in. x 3-7/16 in. x 16 ft.



Back Band
1-3/16 in. x 4-1/2 in. x 16 ft.



Adjustable Back Band
1-11/32 in. x 1-13/32 in. x 16 ft.



Inside Corner Post
1-1/4 in. x 1-1/4 in. x 10 ft.



Rams Crown
1-13/32 in. x 2-1/16 in. x 16 ft.



Lattice
1/4 in. x 1-1/2 in. x 16 ft.



Rake
1 in. x 2 in. x 16 ft.

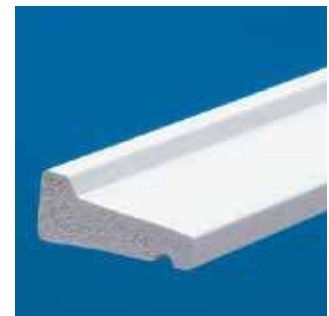

Drip Cap
11/16 in. x 1-5/8 in. x 16 ft.

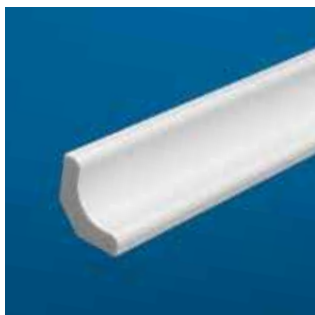

Cove Moulding
3/4 in. x 3/4 in. x 16 ft.



Base Cap
11/16 in. x 1-1/8 in. x 16 ft.



Quarter Round
3/4 in. x 3/4 in. x 16 ft.



Water Table
2 in. x 2-3/4 in. x 16 ft.



Bed Mould
9/16 in. x 1-5/8 in. x 16 ft.



Brickmould
1-1/8 in. x 2 in. x 7 ft., 10 ft., 17 ft.



Paint Grade Brickmould
1-1/8 in. x 2 in. x 7 ft., 10 ft., 17 ft.

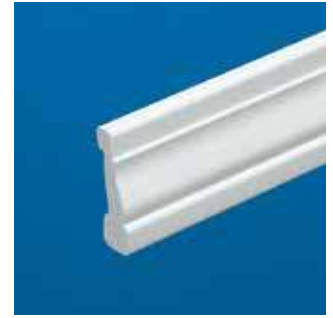

356 Casing
1 1/16 in. x 2-1/4 in. x 16 ft.

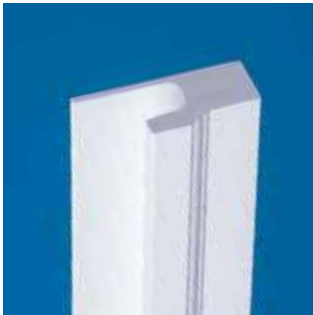

J-Channel Brickmould
1-1/4 in. x 2 in. x 17 ft.

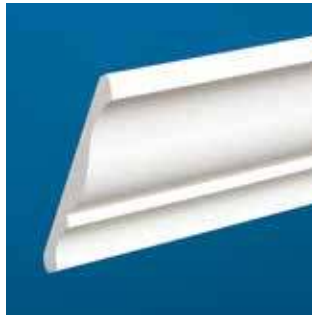

#45 Crown
9/16 in. x 5-1/4 in. x 16 ft.

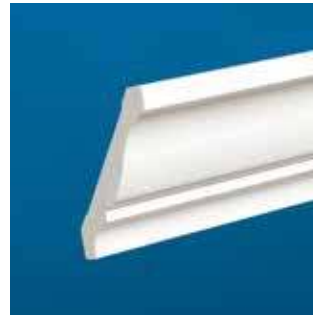

#47 Crown
11/16 in. x 4-5/8 in. x 16 ft.



#49 Crown
11/16 in. x 3-5/8 in. x 16 ft.



Historic Sill
1-3/4 in. x 2-13/16 in. x 16 ft.



New England Sill
1-3/4 in. x 2-1/32 in. x 16 ft.

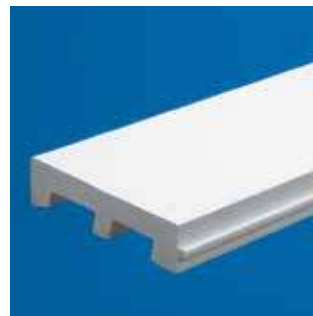

Sill
1-1/4 in. x 5 in. x 16 ft.



Sill Nose
1-5/16 in. x 1-3/8 in. x 16 ft.

Special Order Profiles Available.

Special Order Profiles must be ordered in full box quantities.

Extended lead times will apply. Contact your CertainTeed Territory Manager for product guidelines, minimum quantities and pricing.

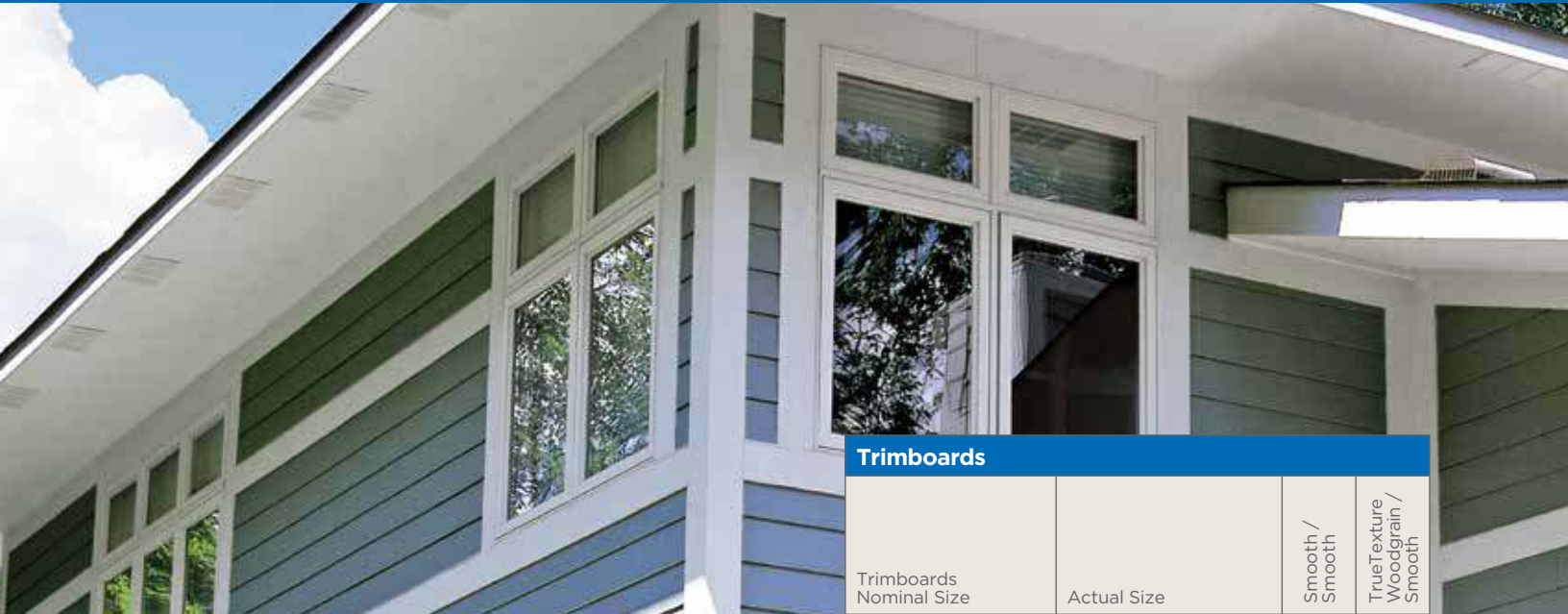

The Finishing Touch

Sometimes it's the little things that make a big difference in creating a distinctive home exterior. Restoration Millwork trim is a subtle finishing touch that brings exterior components beautifully together, creating definition and symmetry, while allowing exterior colors, profiles and design elements to take center stage.

Trimboards

Trimboards Nominal Size	Actual Size	Smooth / Smooth	TrueTexture Woodgrain / Smooth
5/8 in. x 6 in. x 18 ft.	5/8 in. x 5-1/2 in. x 18 ft.	•	•
5/8 in. x 8 in. x 18 ft.	5/8 in. x 7-1/4 in. x 18 ft.		•
5/8 in. x 10 in. x 18 ft.	5/8 in. x 9-1/4 in. x 18 ft.	•	•
5/8 in. x 12 in. x 18 ft.	5/8 in. x 11-1/4 in. x 18 ft.		•
1 in. x 4 in. x 12 ft.	3/4 in. x 3-1/2 in. x 12 ft.		•
1 in. x 6 in. x 12 ft.	3/4 in. x 5-1/2 in. x 12 ft.		•
1 in. x 8 in. x 12 ft.	3/4 in. x 7-1/4 in. x 12 ft.		•
1 in. x 10 in. x 12 ft.	3/4 in. x 9-1/4 in. x 12 ft.		•
1 in. x 12 in. x 12 ft.	3/4 in. x 11-1/4 in. x 12 ft.		•
1 in. x 3 in. x 18 ft.	3/4 in. x 2-1/2 in. x 18 ft.	•	
1 in. x 4 in. x 18 ft.	3/4 in. x 3-1/2 in. x 18 ft.	•	•
1 in. x 5 in. x 18 ft.	3/4 in. x 4-1/2 in. x 18 ft.	•	•
1 in. x 6 in. x 18 ft.	3/4 in. x 5-1/2 in. x 18 ft.	•	•
1 in. x 8 in. x 18 ft.	3/4 in. x 7-1/4 in. x 18 ft.	•	•
1 in. x 10 in. x 18 ft.	3/4 in. x 9-1/4 in. x 18 ft.	•	•
1 in. x 12 in. x 18 ft.	3/4 in. x 11-1/4 in. x 18 ft.	•	•
1 in. x 16 in. x 18 ft.	3/4 in. x 15-1/4 in. x 18 ft.	•	•
5/4 in. x 4 in. x 12 ft.	1 in. x 3-1/2 in. x 12 ft.		•
5/4 in. x 6 in. x 12 ft.	1 in. x 5-1/2 in. x 12 ft.		•
5/4 in. x 8 in. x 12 ft.	1 in. x 7-1/4 in. x 12 ft.		•
5/4 in. x 10 in. x 12 ft.	1 in. x 9-1/4 in. x 12 ft.		•
5/4 in. x 12 in. x 12 ft.	1 in. x 11-1/4 in. x 12 ft.		•
5/4 in. x 4 in. x 18 ft.	1 in. x 3-1/2 in. x 18 ft.	•	•
5/4 in. x 5 in. x 18 ft.	1 in. x 4-1/2 in. x 18 ft.	•	•
5/4 in. x 6 in. x 18 ft.	1 in. x 5-1/2 in. x 18 ft.	•	•
5/4 in. x 8 in. x 18 ft.	1 in. x 7-1/4 in. x 18 ft.	•	•
5/4 in. x 10 in. x 18 ft.	1 in. x 9-1/4 in. x 18 ft.	•	•
5/4 in. x 12 in. x 18 ft.	1 in. x 11-1/4 in. x 18 ft.	•	•
5/4 in. x 16 in. x 18 ft.	1 in. x 15-1/4 in. x 18 ft.	•	•

FinishedEdge™

Edges are heat sealed to prevent dirt from collecting on surface.

Installation

Traditional face nailing or Hidden Fastening System.



TrueTexture™ Finish

CertainTeed's TrueTexture woodgrain finish is molded from real cedar boards, creating a realistic appearance with smooth finish on reverse side.

Smooth Finish

Smooth finish creates the appearance of clean, freshly painted wood, and is smooth on both sides.

Be creative!

From window boxes to bird houses, it's easy to build unique exterior elements with Restoration Millwork trimboards.



J-Pockets and Cut-Outs

The built-in J-pocket eases installation of corner trim and the cut-out allows the trimboard to lie flush with the siding around windows and doors with built-in nail flanges, allowing for more perfect miter cuts at the corners.



Trimboards with J-Pocket			
Nominal Size	Actual Size	Smooth	TrueTexture Woodgrain
5/4 in. x 4 in. x 18 ft.	1 in. x 3-1/2 in. x 18 ft.	•	•
5/4 in. x 6 in. x 18 ft.	1 in. x 5-1/2 in. x 18 ft.	•	•



Trimboards with Cut-out			
Nominal Size	Actual Size	Smooth	TrueTexture Woodgrain
5/4 in. x 4 in. x 18 ft.	1 in x 3-1/2 in. x 18 ft.	•	•



J-Pocket with Cut-out			
Nominal Size	Actual Size	Smooth	TrueTexture Woodgrain
5/4 in. x 4 in. x 18 ft.	1 in. x 3-1/2 in. x 18 ft.	•	•

Fascia Trimboard

Fascia trimboard with built in return leg is designed to work with a wide range of soffit materials. Available in TrueTexture and smooth finish.

Fascia			
Nominal Size	Actual Size	Smooth	TrueTexture Woodgrain
3/4 in. x 8 in. x 18 ft.	3/4 in. x 7-1/4 in. x 18 ft.	•	•
3/4 in. x 10 in. x 18 ft.	3/4 in. x 9-1/4 in. x 18 ft.	•	•

Smooth Finish

TrueTexture Finish



Texture continues on return leg.

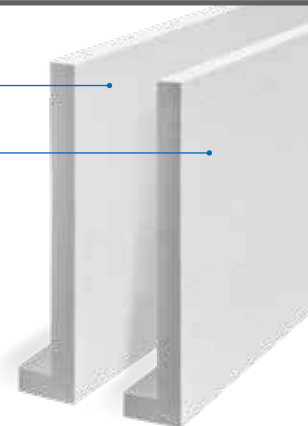

InvisiPro+ Casing



InvisiPro+ provides an attractive, easy-to-install alternative to traditional face nailing. Trimboards feature a hidden nail hem integrated into the j-pocket to conceal fasteners. The end result is a nail-free face with no holes left to fill.

InvisiPro+ Casing		
Nominal Size	Actual Size	Smooth
5/4 in. x 4 in. x 16 ft.	1-1/8 in x 3-1/2 in. x 16 ft.	•

A Great Start, a Quality Finish

Restoration Millwork cellular PVC Skirtboard helps building professionals improve installation time and accuracy, while providing a beautiful finishing touch.

Restoration Millwork Skirtboard meets U.S. building codes requiring 6 in. ground clearance when installing claddings such as fiber cement or engineered wood. It's also ideally suited for use as a transition panel between siding styles. For ultimate style flexibility, Skirtboard panels are reversible, featuring a TrueTexture™ woodgrain finish on one side and a smooth finish on the other.

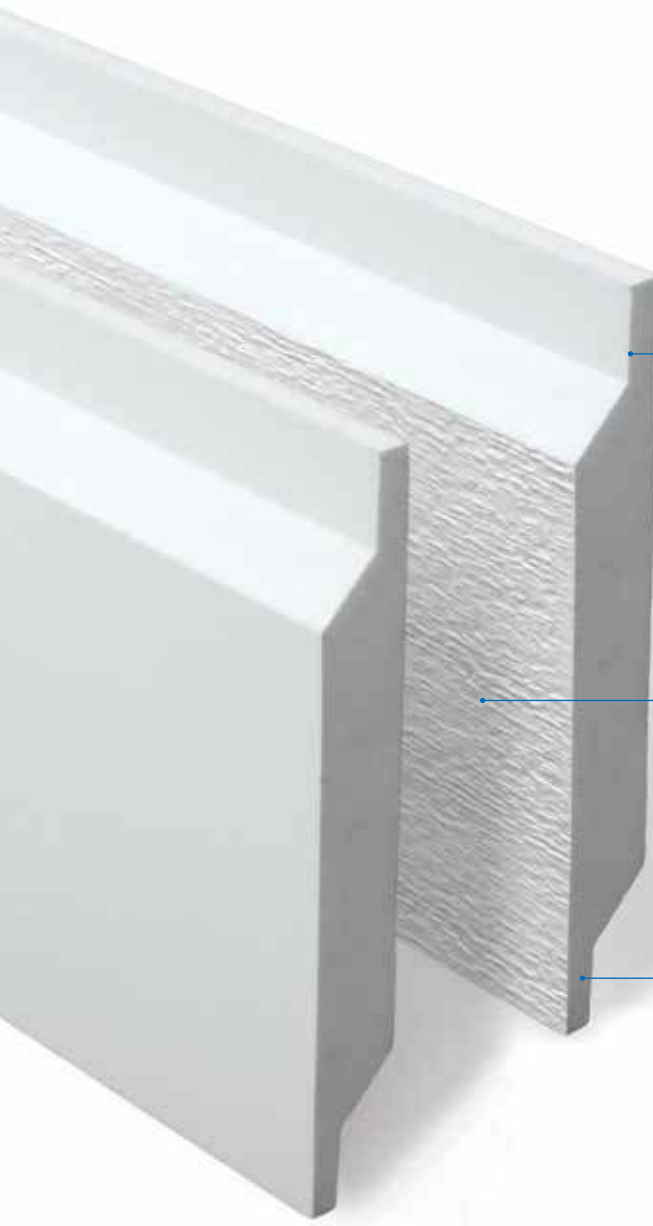

Beveled for Precise Installation

Featuring a slight angle at the top lap, Skirtboard is designed to match the angle of most hardboard cladding panels, when used as a starter strip, enabling a perfect fit, without gaps or spaces.

DualStart® Design

Reversible Skirtboard (patent-pending) panels feature a CertainTeed exclusive TrueTexture woodgrain finish on one side, and a smooth finish on the other. The top and bottom edges are identical so when flipped over there will always be a beveled edge at the top to set the first course and built-in drip edge at the bottom.

Built-In Drip Edge

Skirtboard panels are identically notched on both top and bottom, creating a natural drip edge, stopping water from traveling back to the house.

Skirtboard		
Skirtboard Nominal Size	Actual Size	TrueTexture Woodgrain / Smooth
5/4 in. x 6 in. x 12 ft.	1 in. x 5-1/2 in. x 12 ft.	•
5/4 in. x 8 in. x 12 ft.	1 in. x 7-1/4 in. x 12 ft.	•



Use as a Skirtboard or Transition Panel

Skirtboard can be used as a Skirtboard when starting your hardboard cladding installation, as well as a trimboard for use in transition areas between different siding styles. Skirtboard is ideal for lap siding and perfection shingles, as well as with shapes.





Corners

One-piece Corners Nominal Size	Actual Size	Smooth	Smooth J-Pocket	TrueTexture Woodgrain	TrueTexture Woodgrain J-Pocket
5/4 in. x 4 in. x 4 in. x 10 ft.	1 in. x 3-1/2 in. x 3-1/2 in. x 10 ft.	•	•	•	•
5/4 in. x 4 in. x 4 in. x 20 ft.	1 in. x 3-1/2 in. x 3-1/2 in. x 20 ft.	•	•	•	•
5/4 in. x 6 in. x 6 in. x 10 ft.	1 in. x 5-1/2 in. x 5-1/2 in. x 10 ft.	•	•	•	•
5/4 in. x 6 in. x 6 in. x 20 ft.	1 in. x 5-1/2 in. x 5-1/2 in. x 20 ft.	•	•	•	•

Style Around Every Corner

Restoration Millwork adds a finishing touch around every corner. One-piece corner components add style and corners are available in natural white, and like all Restoration Millwork components, can be painted to match or coordinate with other exterior elements. Traditional face nailing methods can still be used on every one-piece corner style.



Smooth Finish

Smooth finish creates the appearance of clean, freshly painted wood.

TrueTexture™ Finish

CertainTeed's TrueTexture woodgrain finish is molded from real cedar boards, creating a realistic, rustic appearance.

Pre-Cut and Pre-Mitered for Fast, Easy Installation

Durable, cellular PVC Restoration Millwork Column Wraps are now available directly from CertainTeed. Column wraps are pre-cut and pre-mitered to slide around and swing closed on existing wood load-bearing 4 in. x 4 in. or 6 in. x 6 in. porch posts. Because most of the assembly and gluing is already done, Restoration Millwork Column Wrap makes installation fast and easy, always square, true, and accurate.

Simple and versatile, with 2 column widths — 8 in. x 8 in. and 10 in. x 10 in., and 2 Cap/Base Trim set designs — Restoration Millwork Column Wrap helps installations move faster, while adding long-lasting beauty to porch designs and other exterior areas.



2 Styles, 2 Sizes

8 in. x 8 in. x 9 ft.

10 in. x 10 in. x 9 ft.

Each size available with:
Estate Cap/Base Trim Set
Classic Cap/Base Trim Set



The Estate
Cap/Base Set



**Pre-Cut and
Pre-Mitered...
Always square,
true, and
accurate.**



The Classic Cap/Base Set

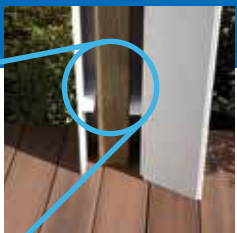

1. Attach Blocking

Secure the included blocking around an existing 4 in. x 4 in. or 6 in. x 6 in. load-bearing post. The blocks help reinforce and square up the column installation.



2. Slide Wrap Around an Existing Post

Slide the three-sided Column Wrap with the swinging door closure around the post. Column Wrap comes cut to length for 9 ft. openings, and can be field cut to 8 ft. or adjusted to work up to 10 ft.



3. Swing Door Closed

Apply PVC adhesive to facing edges and close the door on the wrap for a clean, secure finish. Pre-cut, pre-mitered, and in 2 widths, with 2 Cap/Base Trim Sets to choose from, Column Wraps add a touch of traditional elegance.



The Craftsman's Choice

The mark of true craftsmanship is an imagination that knows no limits and the skill to bring ideas to life. Restoration Millwork sheets offer a blank canvas of design possibilities. Available in a full selection of custom and standard sizes and shapes, sheets can be used to create distinctive, one-of-a-kind exterior elements that are as beautiful as they are durable.

TrueTexture™ Finish

CertainTeed's TrueTexture woodgrain finish is molded from real cedar boards, creating a realistic appearance with smooth finish on reverse side.

Smooth Finish

Smooth finish creates the appearance of clean, freshly painted wood, and is smooth on both sides.

Sheets		Smooth / Smooth	TrueTexture Woodgrain / Smooth
Sheets Nominal Size	Actual Size		
3/8 in. x 4 ft. x 8 ft.	3/8 in. x 4 ft. x 8 ft.	•	•
3/8 in. x 4 ft. x 10 ft.	3/8 in. x 4 ft. x 10 ft.	•	
3/8 in. x 4 ft. x 18 ft.	3/8 in. x 4 ft. x 18 ft.	•	
1/2 in. x 4 ft. x 8 ft.	1/2 in. x 4 ft. x 8 ft.	•	•
1/2 in. x 4 ft. x 10 ft.	1/2 in. x 4 ft. x 10 ft.	•	
1/2 in. x 4 ft. x 18 ft.	1/2 in. x 4 ft. x 18 ft.	•	
5/8 in. x 4 ft. x 8 ft.	5/8 in. x 4 ft. x 8 ft.	•	
5/8 in. x 4 ft. x 10 ft.	5/8 in. x 4 ft. x 10 ft.	•	
5/8 in. x 4 ft. x 18 ft.	5/8 in. x 4 ft. x 18 ft.	•	
3/4 in. x 4 ft. x 8 ft.	3/4 in. x 4 ft. x 8 ft.	•	•
3/4 in. x 4 ft. x 10 ft.	3/4 in. x 4 ft. x 10 ft.	•	
3/4 in. x 4 ft. x 12 ft.	3/4 in. x 4 ft. x 12 ft.	•	
3/4 in. x 4 ft. x 18 ft.	3/4 in. x 4 ft. x 18 ft.	•	
3/4 in. x 4 ft. x 20 ft.	3/4 in. x 4 ft. x 20 ft.	•	
1 in. x 4 ft. x 8 ft.	1 in. x 4 ft. x 8 ft.	•	
1 in. x 4 ft. x 10 ft.	1 in. x 4 ft. x 10 ft.	•	
1 in. x 4 ft. x 12 ft.	1 in. x 4 ft. x 12 ft.	•	
1 in. x 4 ft. x 18 ft.	1 in. x 4 ft. x 18 ft.	•	
1 in. x 4 ft. x 20 ft.	1 in. x 4 ft. x 20 ft.	•	

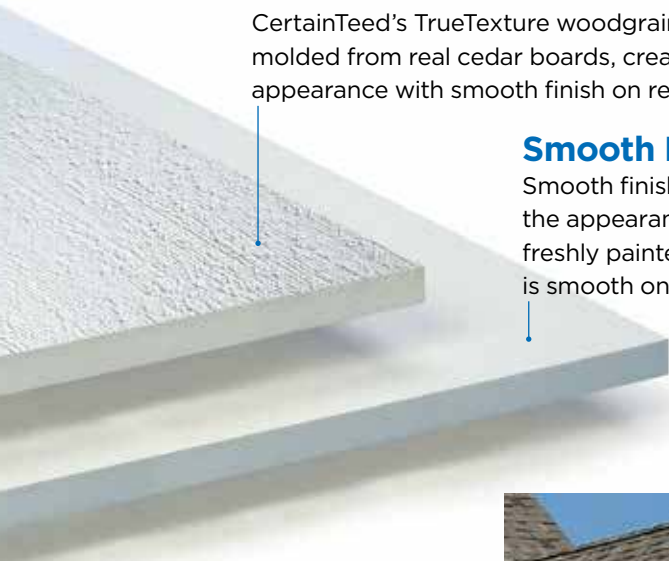



Start with one of the many profiles available or make your own mouldings and trim pieces.



Beadboard

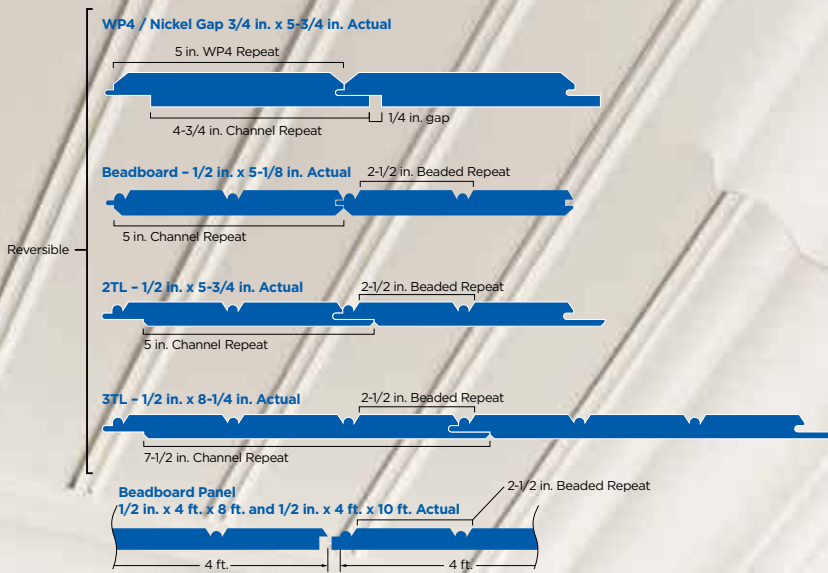

Beadboard, 2TL, 3TL and WP4 are designed to be reversible, which allows for two unique looks from the same board.



front

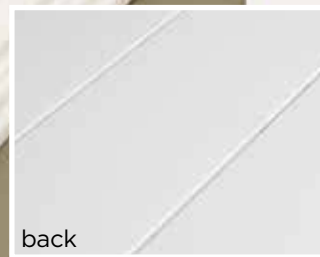

back

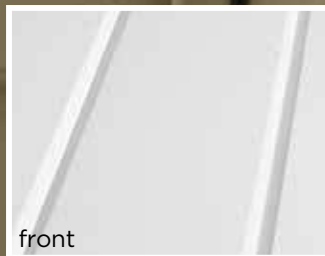

front

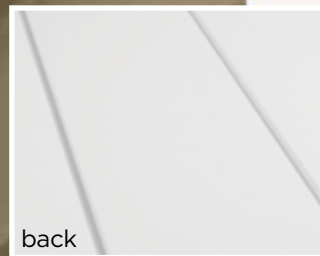

back

Restoration Millwork now offers reversible panels pre-cut with a WP4 groove on one side and a 1/4 in. Nickel Gap on the other to help create the desired look for your project. The new profiles were developed with the TightLap™ design to provide a larger nailing area and easier installation.



The Choice is Yours!

Whether the job calls for Traditional Beadboard, larger panels or craftsmen inspired patterns, Restoration Millwork cellular PVC offers the right solution to make an authentic statement. Now, with more Beadboard options and the new TightLap™, there's no limit to what you can create.



Reversible pattern allowing for WP4 groove or 1/4 in. Nickel Gap in one board

WP4* / Nickel Gap
(3/4 in. x 6 in. x 18 ft. Nominal)
With TightLap™
*patent pending



Beadboard with Traditional Tongue & Groove

Beadboard
(1/2 in. x 5-1/2 in. x 18 ft. Nominal)
With Tongue & Groove

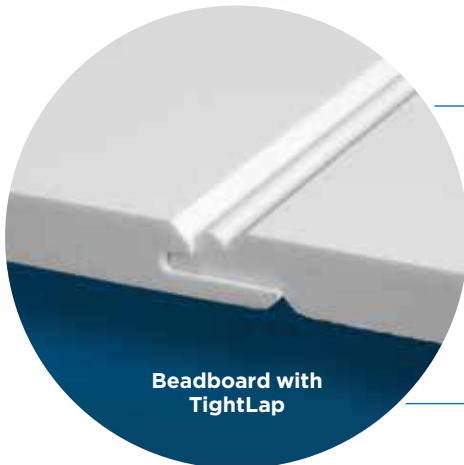

Beadboard with TightLap

Beadboard 2TL
(1/2 in. x 6 in. x 18 ft. Nominal)
With TightLap™

TightLap is designed to have a larger nailing area with the security of tongue and groove.

Beadboard 3TL
(1/2 in. x 8-1/2 in. x 18 ft. Nominal) With TightLap™
installs up to 30% faster than standard 5 in. beadboard



Beadboard Panel Standard Lap

Beadboard Panel
(1/2 in. x 4 ft. x 8 ft. Nominal)
(1/2 in. x 4 ft. x 10 ft. Nominal)



CertainTeed products are designed to work together and complement each other in color and style to give any home a beautiful finished look.



VINYL SIDING



POLYMER SHAKES & SHINGLES



INSULATED SIDING



METAL SIDING



ROOFING AND VENTILATION



STONE



HOUSEWRAP



VINYL CARPENTRY® TRIM



PVC EXTERIOR TRIM & BEADBOARD



VINYL & METAL SOFFIT



CertainTeed

Ceilings • Gypsum • Insulation • Roofing • Siding • Trim

20 Moores Road, Malvern, PA 19355 | 800-233-8990 | certainteed.com

©02/24 CertainTeed, Printed in the USA, Code No. 17-00-71-US-EN